



**BIO**

# **FITOCLIMA WALK-IN HP**

HIGH PERFORMANCE LIGHTING AND ENVIRONMENTAL CONTROL  
SINGLE-TIER PLANT GROWTH CHAMBERS  
CONTROLLED ENVIRONMENT ROOMS



● ● ● ●  
**aralab**





**ARALAB** is a company specialized in designing, developing, manufacturing and servicing of high quality climatic chambers and controlled environment rooms.

Since 1985 we have been perfecting ways to create and control temperature, humidity, light, air flow and many other environmental conditions.

Only the highest quality components are used to manufacture our chambers so customers can have the best equipment for their research and testing purposes.

**Control the environment, your own climate.**



**FitoClima High Performance chambers are suitable for plants that require great amounts of light intensity as well as a broad light spectrum.**

#### COMMON APPLICATIONS INCLUDE

- WHEAT
- CORN
- RICE
- COTTON
- COFFEE
- CORK
- LARGE AND TALL PLANTS IN GENERAL
- PLANTS NEEDING HIGH AND INTENSE LIGHT



Certified ISO:9001 for its Quality Management System



#### KEY FEATURES

- Temperature, Humidity, Light intensity and Air Flow controlled with consistent precision through the years
- Lights located at the ceiling inside a separately cooled glass barrier keeping environmental conditions stable inside growth room whilst providing high light intensity
- Latest generation of 'full spectrum' CMH lamps or LEDs, allowing for great energy savings
- Adaptive future proof design, with easily removable trays for optimal height distance from light source
- All environmental conditions easily programmable with the new ClimaPlus® multicolour touchscreen interface
- Research protection features, with configurable high/low temperature and humidity alarms and automatic remote notifications

## TECHNICAL SPECIFICATIONS

### FITOCLIMA HP SINGLE TIER GROWTH ROOMS

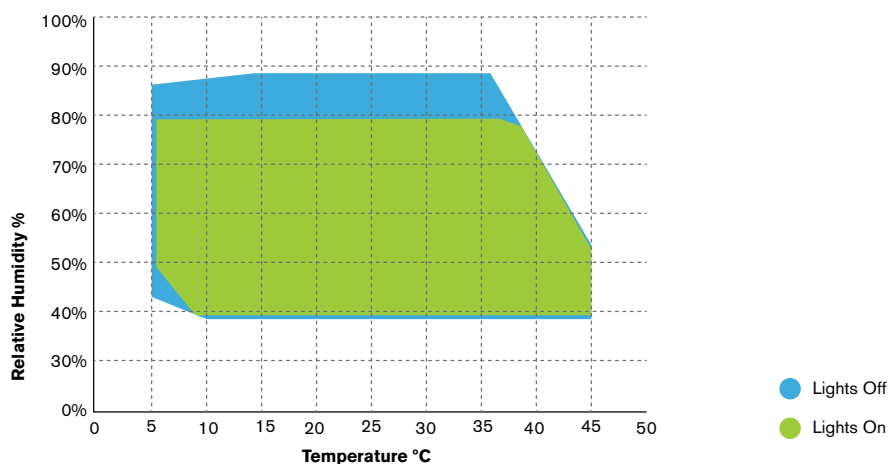

TEMPERATURE RANGE		LIGHTS ON: +5°C to +45°C LIGHTS OFF: 5 °C to +45°C
TEMPERATURE STABILITY		± 0,5°C
TEMPERATURE UNIFORMITY		± 1,0°C
HUMIDITY RANGE <sup>[1]</sup>		LIGHTS ON: 40 to 80% rH LIGHTS OFF: 40 to 90% rH
HUMIDITY STABILITY		± 2% rH
HUMIDITY UNIFORMITY		± 2,5 % rH
TIERS		Single tier, occupying the whole internal area for the most efficient use of the available space
STANDARD GROWTH AREA <sup>[2]</sup> FitoClima 10.000 HP FitoClima 25.000 HP		5,2 m <sup>2</sup> 11,8 m <sup>2</sup>
LIGHTS		Latest generation of 'full spectrum' CMH lamps with electronic ballasts and dimming function. Lights located at the ceiling inside a separately cooled glass barrier, protecting environmental conditions inside the growth area. LED options also available
LIGHT INTENSITY Approximate intensity at 1.0 00mm from ceiling light source Up to 600 µ moles /m <sup>2</sup> s ( approx. 42.000 Lux) Up to 1.100 µ moles /m <sup>2</sup> s (approx. 78.000 Lux)		<b>Light Type</b> Single CMH luminaire (or LED alternative) Double CMH luminaire (or LED alternative)
TABLES AND TRAYS <sup>[4]</sup>		Special tables and trays for single tier rooms provide 2 possible growth heights: (Floor level, at 1.960mm from ceiling/lights) First tray level, at 1.550mm from ceiling/lights Second tray level at 1.100mm from ceiling/lights
AIRFLOW SPEED		Airflow speed adjustable by set point % on the controller
INTERNAL VOLUMES <sup>[5]</sup>		Standard models ranging from 10.000 to 28.000 liters

### TEMPERATURE & HUMIDITY WORKING RANGE



## DIMENSIONS AND DRAWINGS

### ● ● ● ● FITOCLIMA 10.000 HP

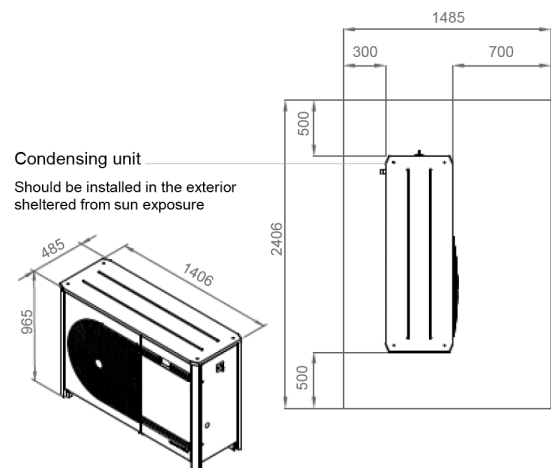
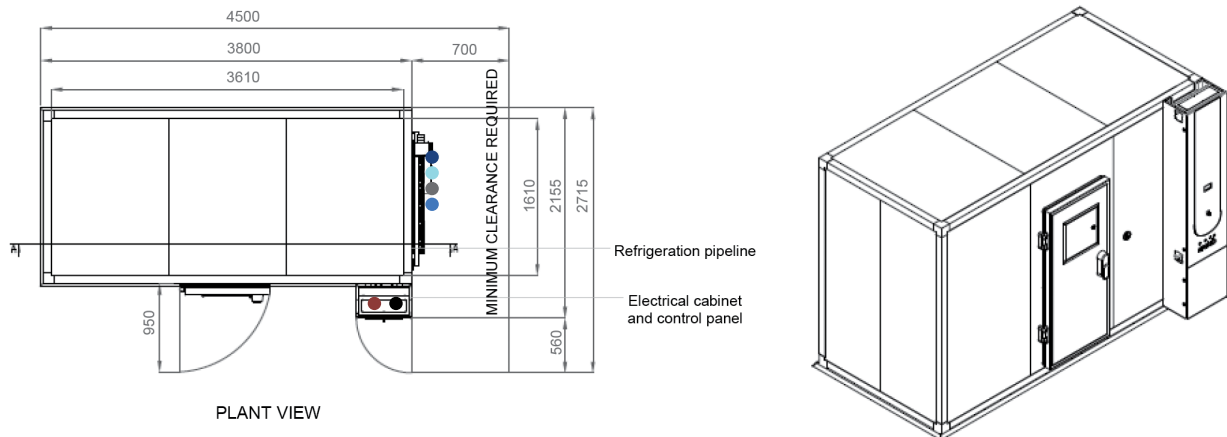
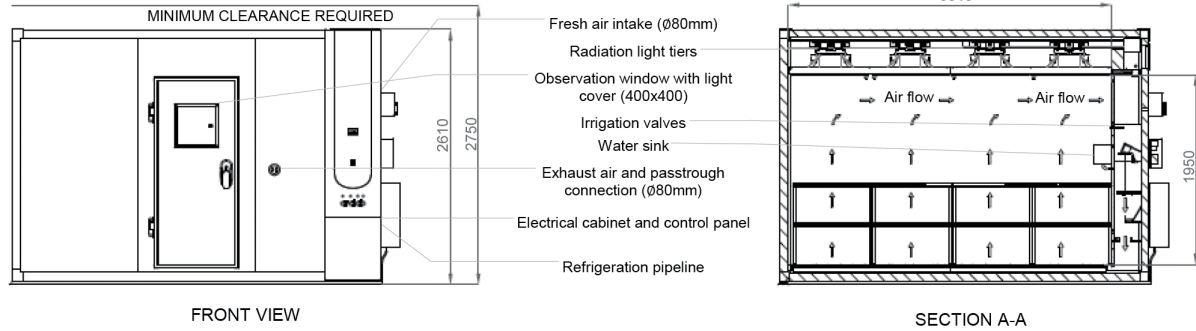

<b>EXTERNAL DIMENSIONS (HxWxD) (mm)</b>		2.610 x 4.500 x 2.715
<b>INTERNAL DIMENSIONS (HxWxD) (mm)</b>		1.950 x 3.310 x 1.610



- Standard refrigeration system is air cooled
- Services hub installation needs:
  - ½" demineralized water supply
  - 50mm water drain at floor level
  - ½" tap water supply
  - ½" irrigation valve system
- Electrical cabinet installation needs:
  - Supply power: 400VAC, 50Hz, 32A / 3-Phase + Neutral + Ground
  - Electrical protection: Circuit breaker 3 x 32A + N with 300mA differential
  - 3-Phase electrical cable RV-K 5G6 on the top
  - RJ45 Ethernet socket communication port on the top

## DIMENSIONS AND DRAWINGS

### ● ● ● ● FITOCLIMA 25.000 HP

EXTERNAL DIMENSIONS (HxWxD) (mm)		3.150 x 3.410 x 5.430
INTERNAL DIMENSIONS (HxWxD) (mm)		2.340 x 3.210 x 3.610

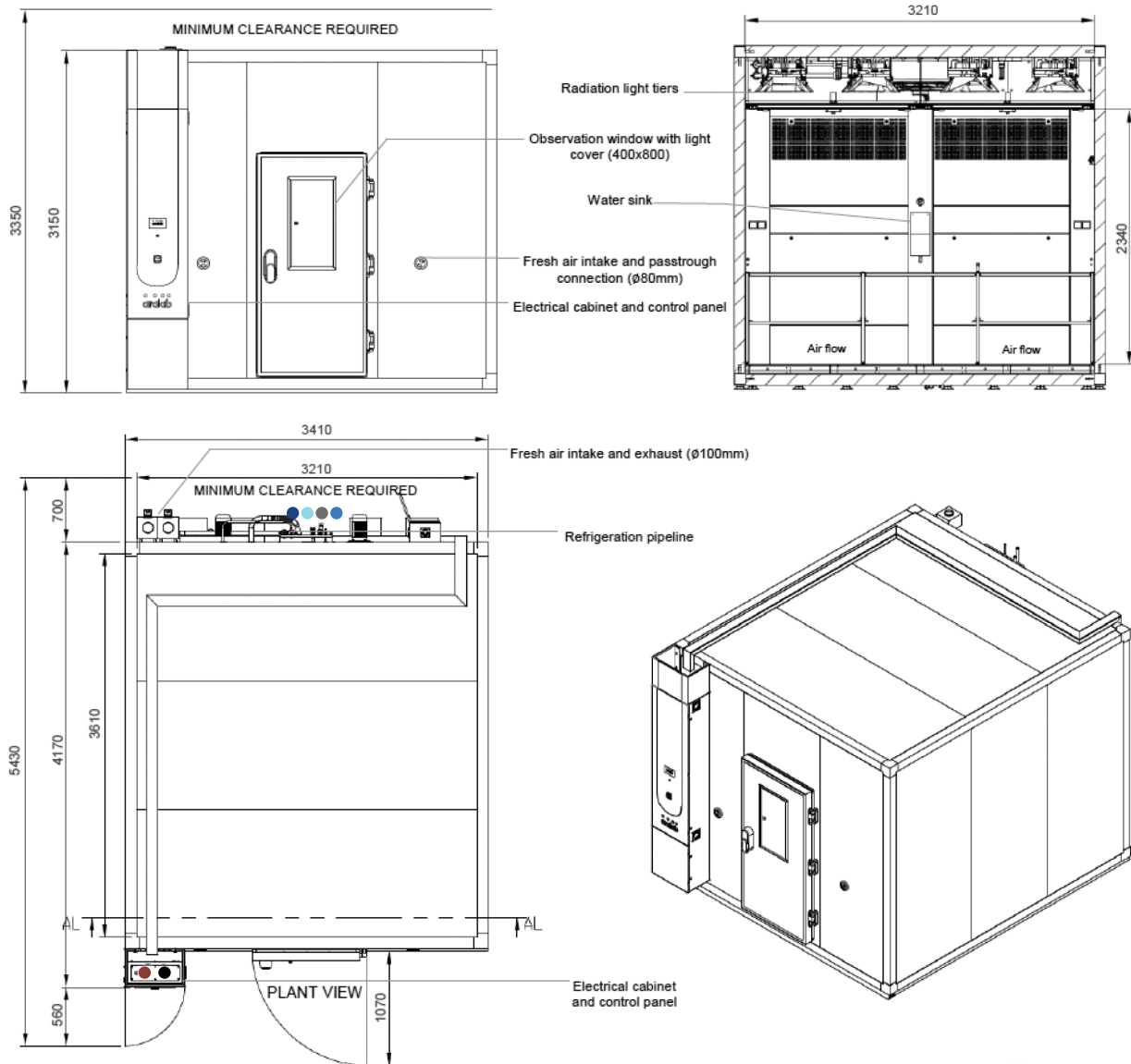

- Standard refrigeration system is air cooled
- Services hub installation needs:
  - 3/4" demineralized water supply
  - 50mm water drain at floor level
  - 3/4" tap water supply
  - 3/4" irrigation valve system
- Electrical cabinet installation needs:
  - Supply power: 400VAC, 50Hz, 70A / 3-Phase + Neutral + Ground
  - Electrical protection: Circuit breaker 3 x 80A + N with 300mA differential
  - 3-Phase electrical cable RV-K 3x25 +2G16 on the top
  - RJ45 Ethernet socket communication port on the top

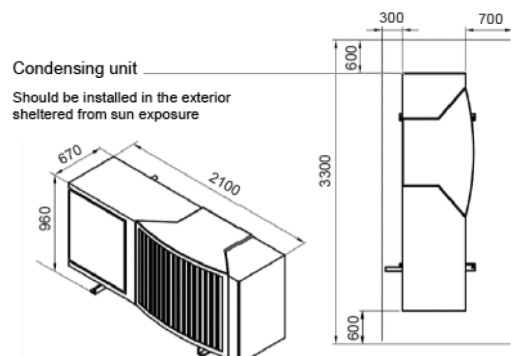

## EQUIPMENT DESCRIPTION



### CONSTRUCTION

- Exterior: EN 14509 sandwich type high density injected polyurethane foam modular panels, 80 mm thick (other thicknesses available for different specific insulation requirements) with galvanized steel in light gray plastic finish. CFC-free.
- Floor: slip resistant AISI 304 stainless steel floor
- Walls: Galvanized steel with white epoxy paint
- 80mm Ø side port
- New generation multi-color touch-screen ClimaPlus controller
- Observation window on the door at eye level
- Door with double gasket, key lock and safety opening mechanism from the inside
- Open door alarm with configurable time-out function
- Free slots for connecting and integrating external devices with the ClimaPlus controller (CO<sub>2</sub>, O<sub>2</sub> control, Auto Irrigation, Aeration, Radiometers and other)



### CLIMATIC CONTROL

- Air based, CFC free, mechanical refrigeration by sealed condenser group
- Dual heating technology with hot gas by-pass and stainless steel electric heaters
- Humidification by spray nozzles (with or without compressed air)
- Dehumidification by condensation on the cooling system evaporator
- PT100 RTD temperature sensor and capacitive humidity sensor



### AIR FLOW

- Dynamic airflow with EC (variable) blower
- Forced in upward direction through perforated floor
- Vertical laminar airflow across all growth area
- Air renovation through adjustable lateral port-holes
- Airflow velocity adjustable at the ClimaPlus© controller

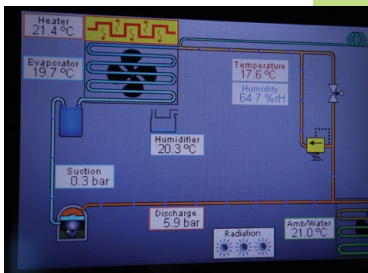

### RESEARCH PROTECTION AND SECURITY

- Independent thermostats for maximum and minimum temperature limits
- Automatic cut-off function, in case of excessive heating or cooling
- Configurable maximum and minimum temperature and humidity limits
- Visual and audible alarms for temperature and humidity band limits



## CLIMAPLUS CONTROLLER

- Programmable Logic Controller exclusively developed by Aralab for FitoClima chambers
- Easy to use touch-screen interface
- Controls every environmental variable available for any specific FitoClima model (Temperature, Humidity, Lights, Airflow, CO<sub>2</sub>, O<sub>2</sub> and connected external devices)
- Friendly program editor for creating 32 programs of 24 segments each, allowing the design of complex and comprehensive climatic simulation programs
- Password protection of the controller functions
- Content and research protection feature, with configurable High and Low Temperature and Humidity alarms and automatic notifications
- Managing, monitoring and recording of all alarms
- Non-volatile memory, allowing the automatic restart of previously defined set-points or on-going programs due to power failure, without losing data
- Real-time monitoring of all the functions and active components of the equipment, allowing for a fast and accurate diagnostic in case of malfunction
- Possibility to control and program events by external commands and with external devices
- Graphical view of running programs conditions and environmental variables
- Ethernet (RJ45) port for connecting computers to the controller
- ClimaPlus controller functions also available at the PC/Laptop with the FitoLog software pack

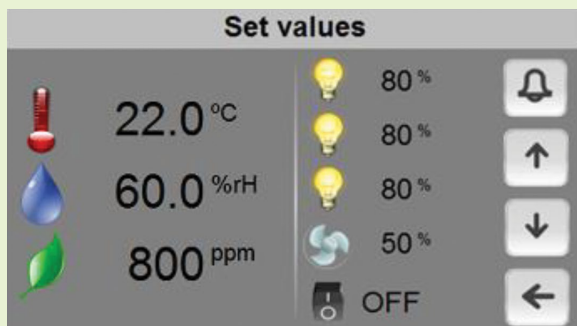

## FITOLOG SOFTWARE

The FitoLog software pack is a set of applications designed to facilitate the managing, monitoring and recording of programs and data from the FitoClima chambers. It consists of 3 applications: **FitoLog**, **FitoLogView** and **FitoProgram**.

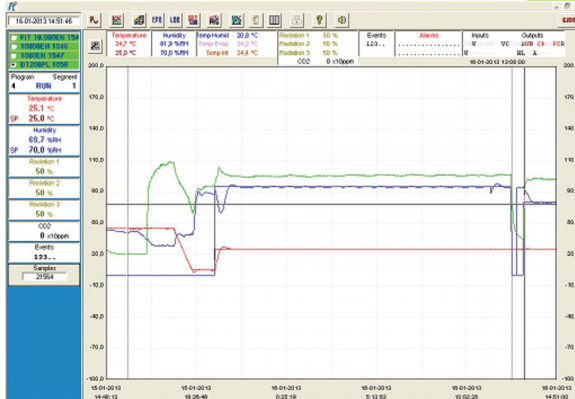

### FITOLOG

Records and displays in real time all data and details related to the set-points, running variables and equipment behaviour. It also retrieves information about the active components of the chamber, running processes, errors, alarms and allows the configuration of periodic or alarm triggered remote notifications (by email or SMS, depending on existing connections and accessories).

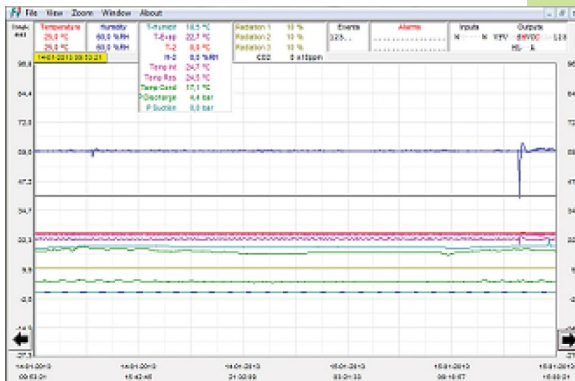

### FITOLOGVIEW

It is a working tool to process the data recorded by the FitoLog program. One can view, print and export the log contents to other file types, and analyse the data in other data management software (Excel, Star Office, Access or others).

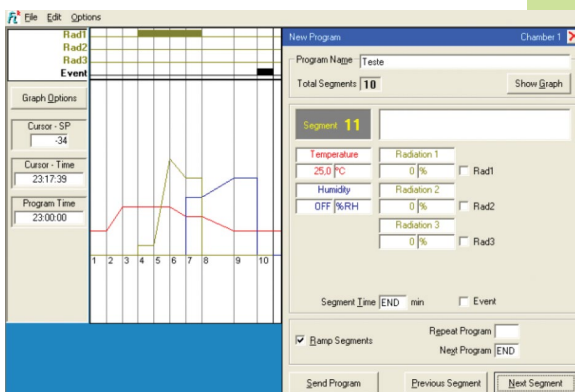

### FITOPROGRAM

This application simplifies the creation of programs and its integration on the chamber ClimaPlus controller. Up to 32 programs, each with 24 segments, can be designed and linked to create detailed environmental profiles and simulations.

## RESEARCH SECURED WITH ALARMS, NOTIFICATIONS, FAST DIAGNOSTICS AND PROMPT TROUBLESHOOTING

With FitoLog it is possible to gather data from each of the chambers systems, which makes it a very useful tool to diagnose any necessary maintenance. This tool works as the “black box” of the equipment, giving Aralab technicians the necessary data to remotely carry out a fast and efficient diagnostic. All that is needed is a FitoLog file.



## FITOCLIMA HP LIGHTING OPTIONS



## COMMON ACCESSORIES

### PLEASE CONSULT ARALAB FOR OTHER ITEMS

FitoLog® software pack for PC/Laptops, enabling data monitoring, logging and managing operations directly on a computer

Quantum light meter for precise light intensity control in micromoles/m<sup>2</sup>/s

Humidity control

CO<sub>2</sub> controlling and monitoring unit with controller and software integration

Tables and trays in perforated stainless steel with 2 growth height positions

LED lighting with fixed or configurable spectral distribution

Positive/Negative pressure unit with HEPA filters

Additional electrical sockets for powering external devices inside room

Wireless connections between FitoLog and PC/Laptop

Automatic irrigation plant nurturing valve

Aeration kit for Algae or Hydroponic cultures

Integrated water tank with electric pump and security valve

Wall mounting conductivity meter, for water quality control, with assembling accessories

5 stage Reverse Osmosis with pre decalcification water treatment system



## ARALAB FITOCLIMA HP SINGLE-TIER PLANT GROWTH ROOMS

CUSTOMER SPECIFICATIONS AND ACCESSORIES MAY RESULT IN DIFFERENT PRODUCT IMAGES)



WHEAT / CORN RESEARCH ROOM



RICE RESEARCH ENVIRONMENTAL ROOM



HIGH PERFORMANCE LEDS WITH USER ADJUSTABLE SPECTRAL DISTRIBUTION



SET OF 10 FITOCLIMA 25.000 HP GROWTH ROOMS AT AGRICULTURE RESEARCH CENTER



CORK OAK STUDIES GROWTH ROOM



MEDITERRANEAN LANDSCAPE AND EXOTIC PLANT RESEARCH

Features and specifications are subject to change. Aralab continuously studies ways to further develop its products to achieve better performances and overall product quality. As a result, characteristics and specifications provided in this document may be subject to changes.



Let's meet!  
aralab@aralab.pt  
www.aralab.pt  
T: +351 219 154 960



**Control the environment**  
Your own climate